

ATEX Lighting

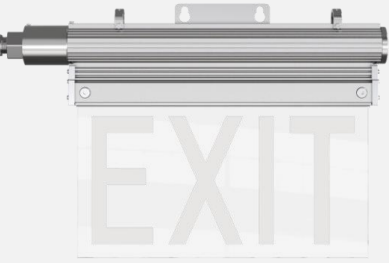

# Atex Zone 1 – 3W LED Emergency Exit Sign

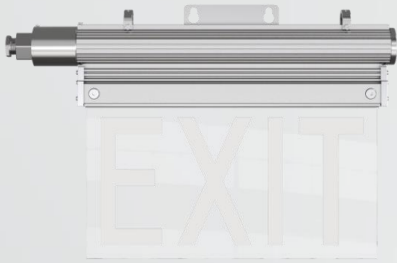



## ATEX Lighting

# Atex Zone 1 - 3W LED Exit Emergency Sign

## Compliance

### ATEX Standard:

II 2 G Ex ib mb IIC T4 Gb  
II 2 D Ex tb IIIC T130°C Db

### IECEx Standard:

Ex ib mb IIC T4 Gb  
Ex tb IIIC T130°C Db

Gas: Zone 1&2  
Dust: Zone 21&22 IP66



## Application

Heavy Industrials Storage Facility

- Paper mills
- Wastewater Treatment Plants
- Loading Docks Platforms
- Offshore Environments
- Chemical Processing Facility
- Petrochemical Processing Facility
- Metallurgical Industry
- Coal Mine
- Food and Alcohol industry



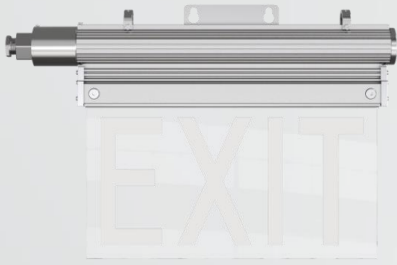

**ATEX Lighting**

## **Atex Zone 1 - 3W LED Emergency Exit Sign**

---

### **Product Description**

The ATEX Zone 1 – 3W LED Exit Sign is a dependable emergency lighting solution designed to provide clear and visible exit guidance in hazardous environments. Built for use in areas where explosive gases or combustible dusts may be present, it delivers consistent performance and safety in critical situations. Emitting a bright green light with a wide beam angle, it ensures exit routes remain clearly always marked.

Constructed from durable materials including an Aluminium housing and tempered glass panel, the sign is built to withstand demanding industrial conditions. Its high ingress protection rating makes it suitable for both indoor and outdoor use, offering resistance against dust and water ingress. The integrated emergency function provides extended backup operation during power outages, helping to maintain safety and compliance. With a long operational lifespan and reliable performance, this exit sign is

### **Warranty**

5 Year Standard Warranty

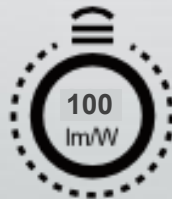

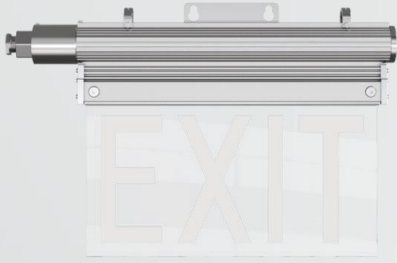

## ATEX Lighting

# Atex Zone 1 - 3W LED Emergency Exit Sign

---

Wattage:	3W
Lumens:	300 lumens
Light Colour:	Green
Rating	Zone 1, 2, 21 & 22
Beam Angle:	180°
Voltage input:	ac 100-277
IP Rating:	IP66
Lifespan:	50,000 Hours
Emergency Time:	180 minutes

Working Temperature: 0°C to +45°C, when battery is charged  
-10°C to +60°C, when battery discharges.



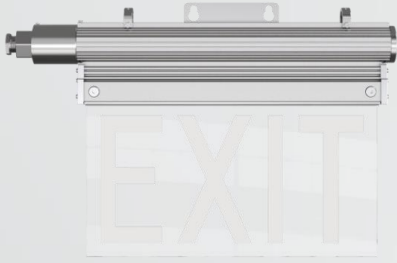

## ATEX Lighting

# Atex Zone 1 - 3W LED Emergency Exit Sign

Warranty: 5 Year Warrantny

Dimensions(MM): L: 464mm x H: 305mm x D: 53mm

Certificates: CE, UKCA, CB & ATEX

Material: Housing: Aluminium  
Exit Sign: Tempered Glass  
Hardware: Aluminium  
Mounting Sling: Aluminium

Application: Perfect for use in petroleum storage, ocean marine and aerospace field, chemical industry, metal treatment, solvent based Paint workshops and alcohol industry.



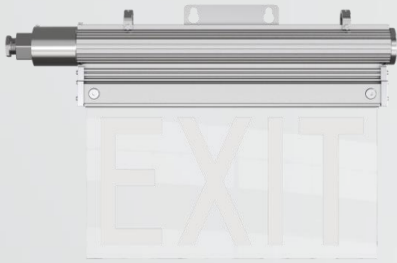

## ATEX Lighting

# Atex Zone 1 - 3W LED Emergency Exit Sign

## Description of Switch:

- 1.Press the switch "ON" once, the EXIT sign and indicator light will flash once, with an ON/OFF interval of 10 seconds.
- 2.With mains electricity disconnected , long press and hold the switch for 3 to 5 seconds to turn off the product. If the EXIT sign needs to be turned on again, it will be activated through mains electricity.

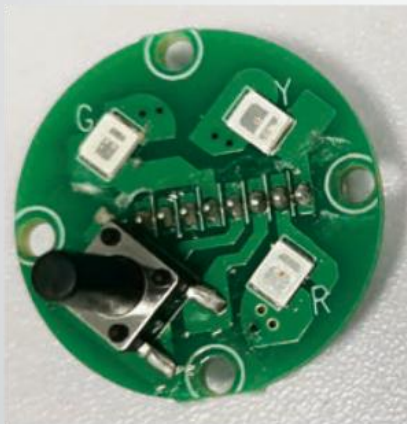

Image: Indicator light LED  
and Tact Switch

## Explanation of Indicator Light:

If three or two indicator lights remain on during initial power on, it is necessary to reset them by detecting the switch: press the switch "ON" for 5 to 6 seconds ->OFF ->ON.

### GREEN:

- 1.Trickle charging.
- 2.Charging indicator, displaying 80% -100% battery capacity.
- 3.Green light on when disconnecting the battery.



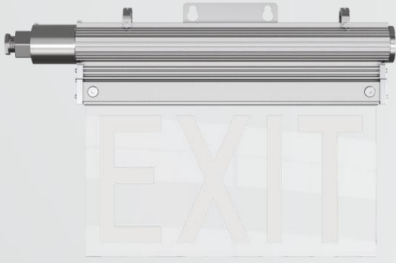

ATEX Lighting

# Atex Zone 1 - 3W LED Emergency Exit Sign

## Dimensions

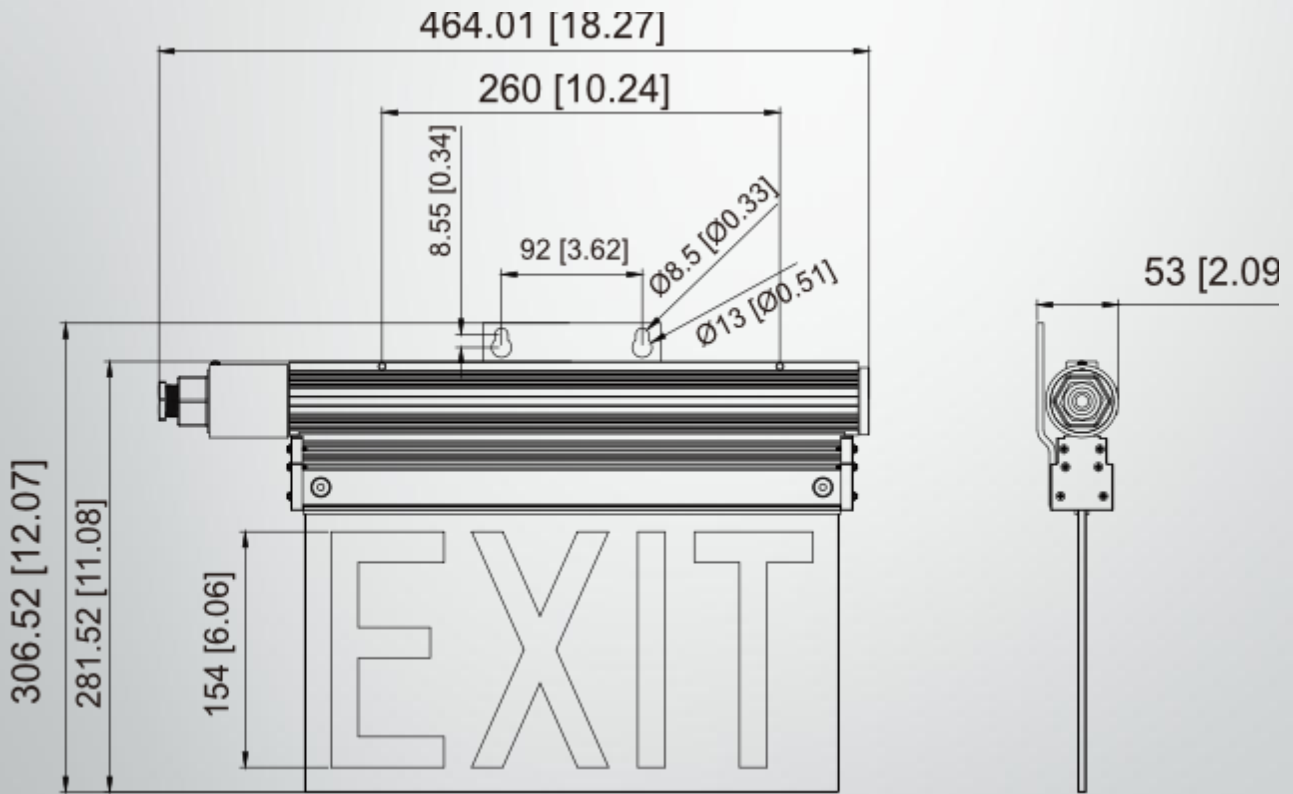

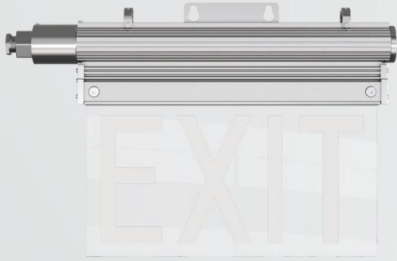

## ATEX Lighting

# Atex Zone 1 - 3W LED Emergency Exit Sign

## Mounting Options

### ◆ Pendant Mounting:



### ◆ Wall Mounting:



### ◆ Pipe Mounting:

